



# Enterprise Analyzer 9.0

Installation Guide

**Micro Focus**  
**The Lawn**  
**22-30 Old Bath Road**  
**Newbury, Berkshire RG14 1QN**  
**UK**  
<http://www.microfocus.com>

© Copyright 2009-2023 Micro Focus or one of its affiliates.

**MICRO FOCUS**, the Micro Focus logo and Enterprise Analyzer are trademarks or registered trademarks of Micro Focus or one of its affiliates.

All other marks are the property of their respective owners.

2023-06-22

# Contents

|   |           |
|---|-----------|
| <b>Overview</b>   | <b>4</b>  |
| Installation Tasks  | 4         |
| Deployment  | 4         |
| Mainframe and Network Server  | 5         |
| Repository Server   | 5         |
| EA Server   | 5         |
| EA Client   | 5         |
| Single User Installation  | 5         |
| Database Setup  | 6         |
| SQL Server Database Setup   | 6         |
| <b>Hardware and Software Requirements</b>                               | <b>8</b>  |
| Repository Server Hardware Requirements                                 | 8         |
| Repository Server Software Requirements                                 | 8         |
| EA Server Hardware Requirements   | 8         |
| EA Server Software Requirements   | 9         |
| EA Client Hardware Requirements   | 9         |
| EA Client Software Requirements   | 10        |
| <b>EA Performance Optimization Guidelines</b>                           | <b>11</b> |
| Choosing Hardware Configuration   | 11        |
| Single User (One Machine)   | 11        |
| Enterprise Installation (Multiple Users Using Separate Database Server) | 12        |
| Software Configuration  | 15        |
| Verification Information  | 15        |
| Parallel Verification   | 15        |
| Choosing the Optimal Number of Queue Processors                         | 15        |
| Using More Computers  | 16        |
| <b>Installing and Uninstalling Enterprise Analyzer</b>                  | <b>17</b> |
| Installing the Database Client  | 17        |
| Installing EA on the Server or Client                                   | 17        |
| Uninstalling Enterprise Analyzer  | 17        |
| <b>Post-Installation Administrative Tasks</b>                           | <b>18</b> |
| Configuring Enterprise Analyzer   | 18        |
| Licensing   | 18        |
| Upgrading Customers   | 19        |
| Concurrent Use  | 19        |
| Enterprise Analyzer Licensing   | 19        |
| Business Rule Manager Licensing   | 19        |
| Micro Focus End User License Agreement                                  | 19        |
| Configuring an ODBC Data Source Name                                    | 27        |
| Creating a Shared Folder for Workspaces                                 | 27        |
| Upgrading Workspaces  | 27        |
| <b>Troubleshooting the Installation</b>                                 | <b>28</b> |
| Troubleshooting Workspace Access  | 28        |

# Overview

This manual describes how to install and configure Micro Focus Enterprise Analyzer (EA), a suite of software products for analyzing and modernizing legacy applications.

Enterprise Analyzer provides insight into the technical reality of complex application portfolios, including

- Tools for application and program level understanding, utilizing extensive metrics, reports, diagrammatic views and querying tools to support myriad of business initiatives.
- Quality Assessment with standard code quality queries to serve as a guidance to a code quality practice in both development and maintenance phases.
- Portability Assessment to help you generate various HTML reports to identify points of interest for migrations.
- In depth analysis tools to promote efficiency in the performance of daily tasks such as field changes, understanding of data propagation through a program, and dead code removal.

Business Rule Manager mines business logic from program code and encapsulates the logic in business rules.

While all products are installed with Enterprise Analyzer, each product is licensed separately.

EA is deployed in a multi-user environment with access to a common repository of application objects. Repository setup is the responsibility of a master user, leaving team members free to focus on their tasks. The database for the repository is assumed to be the customer's own.

EA installations consist of the following components:

- The EA Server which hosts EA workspace files and related support files.
- EA Clients which host the link files used to connect to workspaces on the server.

## Installation Tasks

The table below describes the tasks involved in installing Enterprise Analyzer and the order in which the tasks must be performed:

| Task                    | Order | Notes   |
|-------------------------|-------|---|
| Install Database Client | 1     | The EA package installs SQL Server Express. This is enough for a small sized repository (up to 10 GB).<br>Beyond that, a PostgreSQL database client must be installed wherever the EA client or EA server is installed. Install only if the database client is not already installed. |
| Install EA on Server    | 2     |   |
| Install EA on Clients   | 3     |   |

See *Installation Guide* for more information.

## Deployment

The figure below shows the standard EA deployment scenario. The role each machine performs and its key relationships are described in the following sections.

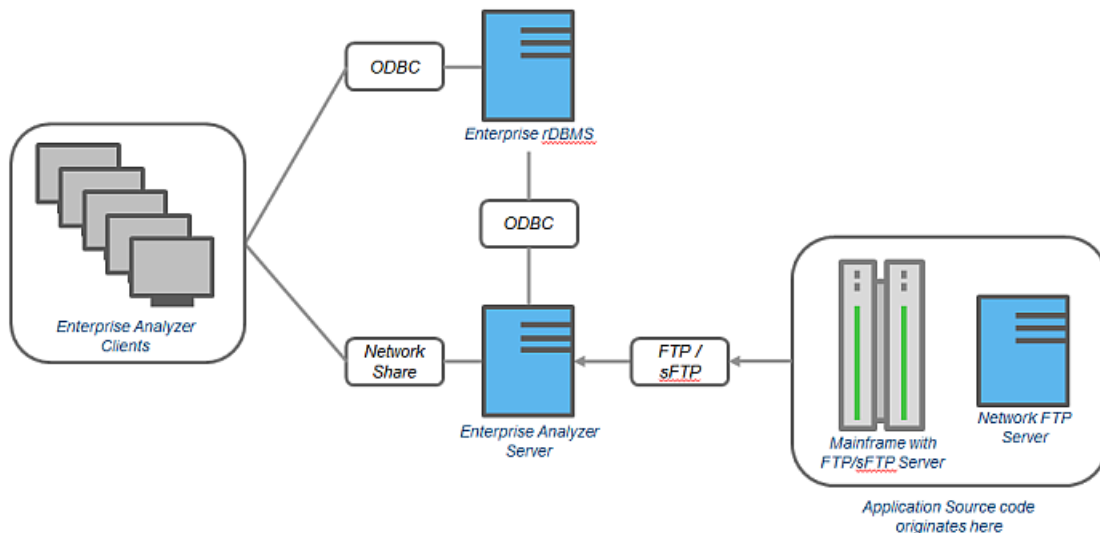

## Mainframe and Network Server

The mainframe typically hosts the application to be modeled in EA. Application source files are downloaded from the mainframe (and, if necessary, a network server) to the EA server via FTP or SFTP.

## Repository Server

The Repository Server hosts the database for one or more multiuser repositories, one repository per EA workspace. This server provides centralized, network-accessible storage for parsed data and analysis output.

## EA Server

The EA Server hosts workspaces, workspace support files (including the copies of application source files EA creates at workspace loading), and workspace output. This server leverages multiple processes to enhance parsing performance in online or batch mode.

Parsed data is sent via ODBC to the repository server. Some analysis output is stored on the EA server as well.

 **Note:** In a multi-user environment, the EA Server cannot reside on the same machine as the EA Repository. The installation program is the same for the EA client and EA server.

## EA Client

EA Clients host the link files that let team members connect to workspaces on the EA server. These clients access repository data stored in the repository server via ODBC.

 **Note:** The installation program is the same for the EA client and EA server.

## Single User Installation

You can configure Enterprise Analyzer to build a workspace on one machine for a single user. You can use Microsoft SQL Server Express - installed by default - to create a workspace on your local machine. EA creates a database for the workspace "on the fly," with no intervention on your part. If you do use SQL Server Express, bear in mind that the Windows user who creates the workspace must have been configured with appropriate permissions in SQL Server Express. The user who installed SQL Server

Express will always have the appropriate permissions. See the SQL Server Express documentation for configuration instructions.



**Restriction:** The database size limit when using the SQL Server Express option is 10 GB.

## Database Setup

If you use PostgreSQL, you must set up a schema for each repository you plan to create. Each EA user who accesses the repository must supply credentials for a database user with appropriate access privileges to the repository.

If you use Microsoft SQL Server, you must set up a SQL Server database for each workspace repository you plan to create. EA users typically supply Windows credentials to access the repository.

## SQL Server Database Setup

If you use Microsoft SQL Server, you must set up a SQL Server database for each workspace repository you plan to create. If EA users connect to the repository through an SQL Server login account, ensure the server authentication property is set to **SQL Server and Windows Authentication mode**, as described below.

The following instructions assume you are using the SQL Server Management Studio tool for SQL Server 2008. The procedure for the SQL Server Management Studio Express tool for SQL Server 2005 is similar.



**Note:** For Windows XP installations using the Italian locale, you must set the Time format in the Control Panel Regional Language Options to "HH:mm:ss" before attempting to verify an EA workspace with a SQL Server repository. Click **Settings > Control Panel > Regional and Language Options > Customize > Time** and choose "HH:mm:ss" from the **Time format** list.

1. Click **Start > Programs > Microsoft SQL Server 2008 > SQL Server Management Studio**.
2. In the Connect to Server screen, select:
  - Database engine in the **Server type** list.
  - The server on which you want to create the repository database in the **Server name** list.
  - Windows Authentication in the **Authentication** list.
3. Click **Connect**. The Microsoft SQL Server Management Studio window opens. In the **Object Explorer** pane, expand the folder for the server. Click **Databases** and choose **New Database** from the right-click menu. The **New Database** window opens.
4. Select the **General** page. In the **Database name** field, enter the name of the database for the repository. Modify the logical name and initial sizes of the database and log files if needed, then click **OK**. The new database is displayed in the **Object Explorer** pane.



**Note:** The database collation should be case insensitive. Additionally, check the SQL Server Management Studio documentation for details on other database settings.

5. If you connect to the workspace repository through a Windows user account, skip the remaining steps. If you connect to the workspace repository through an SQL Server login account, click the server name in the **Object Explorer** pane and choose **Properties** from the right-click menu. The **Server Properties** window opens.
6. Select the **Security** page. In the **Server authentication** area, select **SQL Server and Windows Authentication mode**, then click **OK**.
7. In the **Object Explorer** pane, click **Security > Logins** and choose **New Login** from the right-click menu. The **Login - New** window opens.
8. Select the **General** page. In the **Login name** field, enter the database login name, then choose **SQL Server authentication**. Enter the password for the database login in the **Password** and **Confirm password** fields, then click **OK**. The new login is displayed in the **Object Explorer** pane.

9. In the **Object Explorer** pane, expand the database you created for the workspace repository. Click **Security > Users** and choose **New User** from the right-click menu. The **Database User - New** window opens.

10. Select the **General** page. Define the database user:

- In the **User name** field, type the database user name.
- In the **Login name** field, type the database login name. Use the **Browse** button to browse for the login name.



**Note:** You specify the login name, not the database user name, when you create or connect to a workspace, so it is usually best to make the user name and login name the same.

- In the **Database role membership** pane, check `db_owner`, then click **OK**. The new user is displayed in the Object Explorer pane.



**Tip:** You can use the same login and database user for multiple databases or workspaces.

You can configure Enterprise Analyzer to build a workspace on one machine for a single user. You can use Microsoft SQL Server Express - installed by default - to create a workspace on your local machine. EA creates a database for the workspace "on the fly," with no intervention on your part. If you do use SQL Server Express, bear in mind that the Windows user who creates the workspace must have been configured with appropriate permissions in SQL Server Express. The user who installed SQL Server Express will always have the appropriate permissions. See the SQL Server Express documentation for configuration instructions.



**Restriction:** The database size limit when using the SQL Server Express option is 10 GB.



**Note:** SQL Server database transaction logs can become full, resulting in errors. To avoid this, Micro Focus recommends that you turn off transaction logging or implement automatic log recycling so that normal EA processing is not interrupted. EA does not use the SQL recovery processes so the transaction logging is not required, but it is recommended that the database is regularly backed up.

collation

## Configuring SQL Server for Multi-user Environments

When installing Microsoft SQL Server or SQL Server Express, ensure that the following points have been configured appropriately:

1. Ensure that SQL Server Browser service is running and set to start automatically. You can enable the SQL Server Browser using the SQL Server Configuration Manager or the Windows Services App.
2. Ensure that both the server and client are configured for TCP/IP for 32bit connections. The default port to use is 1433.
3. If Enterprise Analyzer is running on a remote machine to the Microsoft SQL Server or SQL Server Express installations, ensure that the server is configured to accept remote connections.
4. Ensure that the users are registered in the database and they are active and can connect to the SQL Server.
5. Ensure that the users use the `dbo` alias when connecting to the database that holds the workspace.
6. All users must have the `db_datareader` and `db_datawriter` roles. In addition, the master users of the workspace must also be granted the `db_owner` database role.
7. All users must be granted execute permissions on the stored procedures that are created by Enterprise Analyzer.

# Hardware and Software Requirements

The following sections describe the hardware, disk space, operating system, and software requirements for EA installations.

## Repository Server Hardware Requirements

The table below lists the hard drive storage requirements for the Repository Server. For other hardware recommendations, check with support services.

| Type               | Requirement | Notes   |
|--------------------|-------------|---|
| Hard Drive Storage | Variable    | Minimum of 20 GB disk space needed for the software installation of the RDBMS and the EA template database. Plus approximately 60x the size in bytes of the application source code modeled in EA (e.g., 100 MB source = 6 GB). |

## Repository Server Software Requirements

The table below lists the software requirements for the Repository Server:

| Type       | Requirement  |
|------------|--|
| SQL Server | MS SQL Server 2012, 2014, 2016, 2017, 2019, or 2022 (SQL Server 2017 or later is required for Windows 11 or Windows Server 2022) |
| PostgreSQL | PostgreSQL 13 or later.  |

## EA Server Hardware Requirements



The table below lists the hardware requirements for EA Server installations. Hardware requirements may vary depending on the size of the application you are analyzing.

| Type               | Requirement                                 | Notes  |
|--------------------|---|--|
| Processor          | 2.6 GHz Dual Core or 2x 3.0+ GHz Processors | Dual processing capability with multiple cores in a processor or separate physical processors.   |
| Physical Memory    | 3 GB RAM                                    |  |
| Virtual Memory     | 1 GB to 3 GB                                |  |
| Hard Drive Storage | Variable                                    | For EA workspaces, approximately 40x size in bytes of the application source code modeled in EA (for example, 100 MB source = 4 GB).<br><br>For EA software, minimum 200 MB.<br><br>For database client, minimum 200 MB. |



# EA Server Software Requirements

The table below lists the software requirements for EA Server installations:

| Type                                | Requirement   |
|-------------------------------------|---|
| Operating System                    | <p>Microsoft Windows Server 2016, 64-bit</p> <p>Microsoft Windows Server 2019, 64-bit</p> <p>Microsoft Windows Server 2022, 64-bit</p> <p>Microsoft Windows 10, 64-bit</p> <p>Microsoft Windows 11, 64-bit</p>  |
| Database Client                     | For PostgreSQL the 64-bit ODBC Unicode driver is required.  |
| Pre-Requisite Software              | <p> <b>Note:</b> The pre-requisite software is automatically installed by the installer.</p> <ul style="list-style-type: none"> <li>• Sentinel RMS License Manager</li> <li>• .NET 6.0.14</li> <li>• Visual C++ Redistributable (2015-2022) 14.34.31931.0</li> <li>• SQL Server 2022 Express (optional install)</li> <li>• Apache Tomcat 9.0.71 (optional). Needed for EA Web deployment.</li> </ul> |
| Web browser                         | <p>Required to view HTML report outputs or to access the Web client.</p> <ul style="list-style-type: none"> <li>• Internet Explorer 6.0 or later (optional)</li> <li>• Mozilla Firefox 3.6 or later</li> <li>• Chrome 6 or later</li> </ul>   |
| Microsoft Office (optional)         | Required by EA tools with reporting capabilities to save to Microsoft Office file formats. Excel is required for standard deviation charts in the Executive Report.   |
| Microsoft Visio (optional)          | <p>Required to generate output as Microsoft Visio files.</p> <p> <b>Note:</b> When the Visio version is 2013 or later, the .VSDX format is used instead of .VSD.</p>   |
| OpenJDK JRE 8.0 or later (optional) | Required for Java parsing.  |



# EA Client Hardware Requirements

The table below lists the hardware requirements for EA Client installations. Hardware requirements may vary depending on the size of the application you are analyzing.

| Type               | Requirement       | Notes   |
|--------------------|-------------------|---|
| Processor          | 3.0 GHz Processor | Single processor (single or dual core).   |
| Physical Memory    | 1GB RAM           |   |
| Virtual Memory     | 1GB to 3GB        |   |
| Hard Drive Storage | Variable          | <p>For EA software, minimum 200MB.</p> <p>For database client, minimum 200MB.</p> |

# EA Client Software Requirements

The table below lists the software requirements for EA Client installations:

| Type                                | Requirement   |
|-------------------------------------|---|
| Operating System                    | <p>Microsoft Windows Server 2016, 64-bit</p> <p>Microsoft Windows Server 2019, 64-bit</p> <p>Microsoft Windows Server 2022, 64-bit</p> <p>Microsoft Windows 10, 64-bit</p> <p>Microsoft Windows 11, 64-bit</p>  |
| Database Client                     | For PostgreSQL the 64-bit ODBC Unicode driver is required.  |
| Pre-Requisite Software              | <p> <b>Note:</b> The pre-requisite software is automatically installed by the installer.</p> <ul style="list-style-type: none"> <li>• Sentinel RMS License Manager</li> <li>• .NET 6.0.14</li> <li>• Visual C++ Redistributable (2015-2022) 14.34.31931.0</li> <li>• SQL Server 2022 Express (optional install)</li> </ul> |
| Web browser                         | <p>Required to view HTML report outputs or to access the Web client:</p> <ul style="list-style-type: none"> <li>• Internet Explorer 6.0 or later (optional)</li> <li>• Mozilla Firefox 3.6 or later</li> <li>• Chrome 6 or later</li> </ul>   |
| Microsoft Office (optional)         | Required by EA tools with reporting capabilities to save to Microsoft Office file formats. Excel is required for standard deviation charts in the Executive Report.   |
| Microsoft Visio (optional)          | <p>Required to generate output as Microsoft Visio files.</p> <p> <b>Note:</b> When the Visio version is 2013 or later, the .VSDX format is used instead of .VSD.</p>   |
| OpenJDK JRE 8.0 or later (optional) | Required for Java parsing.  |

# EA Performance Optimization Guidelines

This section describes the optimal performance environments in which to run Enterprise Analyzer, including selecting the right hardware configuration for specific types of usage, and optimizing the EA configuration for the selected configuration. The suggestions for performance improvements are focused on the repository build phase of the workspace.

The most time-consuming and hardware-intensive aspects of running Enterprise Analyzer are the source verification and database loading during the workspace build phase. The guidelines include suggestions for improving performance by using multiple Queue Processors and taking advantage of multiple CPU cores, using the parallel verification option which determines the number of used Queue Processors, and guidelines for defining the number of Queue Processors needed for a given configuration of available machines and database server power.

There are two deployment scenarios for Enterprise Analyzer:

- Single User - this is typically a mobile user, such as a consultant on a laptop, who uses the repository for demonstration or assessment purposes.
- Enterprise Installations - several computers are used (one for a database server, one for workspace and multiple user machines).

## Choosing Hardware Configuration

### Single User (One Machine)

#### Minimum Hardware Requirements

| Type               | Requirement                        | Notes  |
|--------------------|------------------------------------|--|
| Processor          | 1.8 GHz, minimum dual core         |  |
| Physical Memory    | 2 GB RAM                           |  |
| Hard Drive Storage | HDD with at least 20 GB free space | For EA workspaces, approximately 60x size in bytes of the application source code modeled in EA (for example, 100 MB source = 6 GB). |

With this minimum hardware configuration you can run Enterprise Analyzer and analyze sources.

#### Suggested Upgrades

The analysis time increases when the number of analyzed sources rises. To reduce the analysis time we recommend you use one of the suggested upgrades:

1. A high speed Solid State Drive (SSD) for storing database tables. This can be added as an external drive; however USB 3.0 or eSATA must be used. This will improve the verification performance by 25% over the minimum configuration.
2. Use a quad core processor such as Intel Core i7 2670QM or any other quad core QE/QM processor. This improves the verification performance by 50% over the minimum system configuration.



**Note:** You must run additional Queue Processors to benefit from the additional cores. See the *Choosing the Optimal Amount Of Queue Processors* section for details.



**Note:** Improved verification performance means that if the project verification takes 100 minutes, and you get 33% performance improvement, the verification time is reduced to 67 minutes.

### Recommended Configuration 1

This configuration gives 33% improved verification performance. The changes from the minimum configuration are marked in bold.

| Type            | Requirement                               | Notes  |
|-----------------|---|--|
| Processor       | 2.0 GHz, 2 cores                          |  |
| Physical Memory | <b>4 GB</b>                               |  |
| Hard Disk Drive | <b>SSD</b> with at least 20 GB free space | For EA workspaces, approximately 60x size in bytes of the application source code modeled in EA (for example, 100 MB source = 6 GB). |

### Recommended Configuration 2

Recommended Configuration 2 gives 50% improved performance of verification. The changes from the minimum configuration are marked in bold.

| Type            | Requirement                             | Notes  |
|-----------------|---|--|
| Processor       | 2.0 GHz, <b>4 cores</b>                 |  |
| Physical Memory | <b>4 GB</b>                             |  |
| Hard Disk Drive | Any type with at least 20 GB free space | For EA workspaces, approximately 60x size in bytes of the application source code modeled in EA (for example, 100 MB source = 6 GB). |

### Performance Configuration

The Performance Configuration is a combination of all upgrades. It gives 66% improved verification performance. The changes from the minimum configuration are marked in bold.

| Type            | Requirement                               | Notes  |
|-----------------|---|--|
| Processor       | 2.0 GHz, <b>4 cores</b>                   |  |
| Physical Memory | <b>4 GB</b>                               |  |
| Hard Disk Drive | <b>SSD</b> with at least 20 GB free space | For EA workspaces, approximately 60x size in bytes of the application source code modeled in EA (for example, 100 MB source = 6 GB). |

## Enterprise Installation (Multiple Users Using Separate Database Server)

A typical environment where large projects will be verified on a regular basis usually consists of 3 types of components:

1. Database server (MS SQL Server, PostgreSQL).

- EA server with the workspace files. This is the machine where EA is installed and where the EA workspace folder is located.

 **Note:** There can be more than one workspace.

- Processing node(s). This is one or more computers running Queue Processors, or hosting the users of the tool.

## Database Server

### Minimum hardware requirements

| Type            | Requirement                                 | Notes  |
|-----------------|---|--|
| Processor       | 2.6 GHz Dual Core or 2x 3.0+ GHz Processors | Dual processing capability with multiple cores in a processor or separate physical processors.                                       |
| Physical Memory | 3 GB RAM                                    |  |
| Hard Disk Drive |   | For EA workspaces, approximately 60x size in bytes of the application source code modeled in EA (for example, 100 MB source = 6 GB). |

The minimum configuration can be up to four concurrent Queue Processors while providing reasonable response time. To improve performance, one of the following upgrades should be used:

- Use faster storage, for example use SSD or storage arrays in RAID0. SSD improves the performance of verification by 33%. 2x SCSI 15000 rpm gives a similar performance improvement.
- Use 8 GB of RAM. Increasing the amount of RAM improves the performance of verification by 15% when using more Queue Processors.
- Network latency between database server and repository server and users should be less than 1ms.

### Recommended hardware configuration

This is the recommended hardware configuration. The changes from the minimum configuration are marked in bold.

| Type            | Requirement                                 | Note   |
|-----------------|---|--|
| Processor       | 2.6 GHz Dual Core or 2x 3.0+ GHz Processors | Dual processing capability with multiple cores in a processor or separate physical processors.                                       |
| Physical Memory | <b>8 GB RAM</b>                             |  |
| Hard Disk Drive | <b>SSD or SCSI 15000 rpm in RAID0</b>       | For EA workspaces, approximately 60x size in bytes of the application source code modeled in EA (for example, 100 MB source = 6 GB). |

### Performance Configuration

You get 33% improved performance of verification.

| Type            | Requirement                           | Note |
|-----------------|---------------------------------------|------|
| Processor       | <b>Xeon CPU E5310 or Core i7 3770</b> |      |
| Physical Memory | 8 GB                                  |      |

| Type            | Requirement                          | Note |
|-----------------|--------------------------------------|------|
| Hard Disk Drive | 2x SCSI 15000 rpm RAID0 or 240GB SSD |      |

 **Note:** Performance configuration can support up to 16 concurrent Queue Processors. Note that user activity through the online tool should be counted as an active Queue Processor.

## EA and Workspace Server

The repository server stores the Enterprise Analyzer workspace folder and files. It is shared on the network so that other users can access it.

 **Warning:** Micro Focus does not recommend combining the EA server and database server (and even processing node) for machines with limited resources.

### Minimum hardware requirements for Repository Server are:

| Type            | Requirement  | Note   |
|-----------------|--|--|
| Hard Disk Drive | Minimum of 20 GB disk space needed for the software installation of the database software. | For EA workspaces, approximately 60x size in bytes of the application source code modeled in EA (for example, 100 MB source = 6 GB).<br><br>Storing your workspace on an SSD drive improves verification performance by 5%-15%, depending on your project. |

## Processing Node/Nodes

This is the machine that runs the Queue Processors and the processes that they kick off. The minimum configuration lets you run a single Queue Processor.

### Minimum System Requirements

| Type            | Requirement                            |
|-----------------|--|
| Processor       | 3.0 GHz single core or 2 GHz dual core |
| Physical Memory | 2 GB                                   |
| Virtual Memory  | 1 GB to 3 GB                           |
| Hard Disk Drive | 1 GB                                   |

The minimum system lets you analyze small volumes of sources and use the basic functionality of the tool. To determine the optimal amount of Queue Processors for your Processing node see *Choosing the Optimal Amount of Queue Processors*. To improve the performance, some of the following upgrades can be used:

1. Use more CPUs or CPU cores. Enterprise Analyzer scales very well so the performance improvement matches the CPU cores added - verification performance is improved by 90% when CPU cores are doubled. The limit is eight physical cores that exclude hyper threading, with 16 queue processors. Each concurrent Queue Processor instance needs up to an additional 2GB of RAM. Make sure your database server can support the additional Queue Processors, see *Database Server*.
2. Use more computers as processing nodes.

### Recommended Configuration (66% improved performance of verification)

| Type            | Requirement         |
|-----------------|---------------------|
| Processor       | 3 GHz quad core CPU |
| Physical Memory | 4 GB                |
| Hard Disk Drive | 4 GB                |

As these processing nodes communicate extensively with the database server, a low-latency network is required between processing node(s) and database server.

 **Note:** For best results, the computers must be on the same local network. You can use a repository server or a database server (or both) as processing nodes, provided that MS Windows is installed.

## Software Configuration

### Verification Information

Verification is the process of analyzing the code loaded into EA. The verification process demands a lot of CPU power. Enterprise Analyzer is designed to use a single CPU core for the main application, but each Queue Processor can run on a separate CPU core. The Queue Processors can even run on multiple computers to help with the verification database loading. There are two ways of initiating the verification process. The first is the online tool (Enterprise Analyzer) and the second is through the Batch Refresh Process (BRP).

### Parallel Verification

By default Enterprise Analyzer uses serial verification both for the online tool and for BRP. If you have a multicore CPU, it is better to use parallel verification.

To enable it in Enterprise Analyzer:

1. Click **Options > Workspace Options**.
2. Click **Verification > Parallel Verification** tab.
3. Select either
  - **Run Parallel Verification in the online tool**
  - **Run Parallel Verification in BRP**
4. Adjust the **Minimum Queue Processors** to improve performance when using an optimized number of CPU cores.

 **Note:** On a quad core CPU you get up to 4 times better performance provided that you use the optimal number of Queue Processors.

### Choosing the Optimal Number of Queue Processors

The optimal number of Queue Processors is related to the number of physical CPU cores available.

If you have X physical CPU cores you should use at least X Queue Processors. Using more Queue Processors than physical CPU cores slightly increases performance but depending on your system setup it could also slow down the verification because of the large number of concurrent IO operations.

 **Note:** Micro Focus recommends using <number-of-physical-CPU-cores> multiplied by two.

# Using More Computers

You can start a new Queue Processor on another computer to help the current verification.



**Note:** EA must be installed on the computer that launches a Queue Processor.

1. Open Micro Focus Enterprise Analyzer Administration and click **Administer > Build New Connection**. This creates a local `.rwp` file to connect to the workspace that needs help during the verification and database loading.
2. Click **Administer > Launch Queue Processor**. The Launch Queue Processor window opens.
3. Specify the local `.rwp` file for the workspace and enter the number of Queue Processors that you want to start.



# Installing and Uninstalling Enterprise Analyzer

Before running an installation program described in this section, make sure you have administrative permissions for the machine on which you are performing the installation. If you do not have administrative permissions, the installation program will not let you continue.



**Note:** You can run the Windows Installer (.msi) installation programs "silently." That is particularly useful when you are installing clients on a network. Check with support services for the appropriate sequence of commands.

## Installing the Database Client

If you use PostgreSQL, a database client must be installed wherever the EA client or EA server is installed.

## Installing EA on the Server or Client

The EA Server hosts EA workspace files and related support files. EA Clients host the link files used to connect to workspaces on the server. Follow the instructions in this section to install EA on the client or server. The Micro Focus License Manager is packaged with the installation.



**Note:** Having the EA server and the database on separate machines could improve performance. The installation program is the same for the EA client and EA server.

1. Double-click `EnterpriseAnalyzer.exe`. Note that there might be a version number in the name of the .exe file.
2. Change the installation directory if not installing to the default location.
3. Select which optional installs you want to include:
  - Microsoft SQL Server - Express Edition
  - Web Client
  - Micro Focus MFA
  - Micro Focus Enterprise Analyzer Administration Tool (needed for server, not really needed for client).
4. Read the End User License Agreement and check **I agree to the End User License Agreement**.
5. Click **Install**.

## Uninstalling Enterprise Analyzer

Follow the instructions below to uninstall an Enterprise Analyzer product. Make sure you close any open EA programs before running the uninstall program.

1. Click **Start > Control Panel > Programs > Programs and Features > Uninstall a program**
2. In the **Uninstall or change a program** window, right-click the product you want to uninstall, then click **Uninstall**. You are prompted to confirm that you want to uninstall the product. Click **Uninstall**.

# Post-Installation Administrative Tasks

Before you can work in Enterprise Analyzer, you must complete the basic administrative tasks described in this section. You are prompted to perform the first of these tasks, configuring the EA, when you complete the installation.



**Important:** Before performing the upgrade on your workspaces, Micro Focus strongly recommends that you back up the database and the workspace folder including the `.rwp` file.

## Configuring Enterprise Analyzer

Use the Configuration Manager in the Enterprise Analyzer Administration tool to configure EA options and displays for the programming languages, dialects, character sets, and products in use at your site.

If you configure your EA for COBOL, for example, you will see only the EA options and displays appropriate for COBOL modernization. You need to configure your EA for PL/I as well, you can come back to the Configuration Manager later and select PL/I in addition to COBOL.



**Note:** The Enterprise Analyzer Administration tool will prompt to be run with elevated privileges. This is required because some features of the tool require write access to the Program Files directory.

### 1. Open the Configuration Manager window.

- If you are installing EA, the Configuration Manager window opens after you finish the installation.
- If you have previously installed EA and want to reconfigure it, choose **Start > Programs > Micro Focus > Enterprise Analyzer > Enterprise Analyzer Administration**. The Enterprise Analyzer Administration window opens. In the **Administer** menu, choose **Configure Micro Focus Enterprise Analyzer**. The Configuration Manager window opens.



**Note:** If EA is open, you are prompted to exit. Click **OK**, then close EA.

### 2. Select each programming language, dialect, and character set in use at your site. Select each EA product you want to use at your site. The core Application Analyzer product is always selected. Select **Additional Tools** to enable tools not used in typical EA configurations. When you are satisfied with your choices, click **OK**.



**Note:** If you modify your EA configuration, make sure you upgrade workspaces created under the previous configuration.



**Note:** The Enterprise Analyzer Administration tool will prompt to be run with elevated privileges. This is required because some features of the tool require write access to the Program Files directory.

## Licensing

Although Enterprise Analyzer and Business Rule Manager) are both installed by the Enterprise Analyzer installer, each product is licensed separately. Follow the instructions in the topics listed below to manage your licenses.

# Upgrading Customers

A customer upgrading from Modernization Workbench version 3.1 or later may use the existing license key to enable Enterprise Analyzer for the same number of users.

## Concurrent Use

You can license Enterprise Analyzer and Business Rule Manager for concurrent use. In this mode, one license key for the purchased number of end users will be registered to a license server and each user instance will contact it for authorization.

## Enterprise Analyzer Licensing

A Sentinel RMS license server is installed with Enterprise Analyzer.

Depending on the licensing model in use at your site, you can manage your license:

- Locally, using the installed Sentinel RMS license server.
- Remotely, using a Sentinel RMS license server that has been configured to manage licenses centrally.



**Note:** The remote license server uses the same software as the local license server that is installed with Enterprise Analyzer.

You will need to apply a license in the Micro Focus License Administration to use Enterprise Analyzer. To start the Micro Focus License Administration, choose **Start > All Programs > Micro Focus License Manager > License Administration**.

- If you use a local license server, you can apply a license using an authorization code or a licensing file in the **Install** tab of the License Administration.
  - **Authorization code:** Enter the 16-character license authorization code for Enterprise Analyzer, then click **Authorize**.
  - **Licensing file:** Enter your downloaded license file (.mflic) by browsing or dropping the file, then click **Install Licenses**.
- If you use a remote license server, click **Options > Advanced Configuration**, then click **Change** in the **License server** field. Enter the IP address or server name of the license server, then click **Save**.

Your License System Administrator can tell you which licensing model your site uses and provide you with the name of the remote license server if needed. For complete information, including how to configure a remote license server, refer to the help provided with the License Administration tool.

## Business Rule Manager Licensing

Trial licenses are not provided for Business Rule Manager. Before you can work with it, you must enter the 16-character license authorization code:

- Choose **Start > Programs > Micro Focus License Manager > License Management System**. In the Licensing System Administration tool, click the Authorize tab, then enter the authorization code in the **Enter authorization code** field and click **Authorize**.

## Micro Focus End User License Agreement

IMPORTANT: LICENSOR PROVIDES LICENSED SOFTWARE TO LICENSEE (HEREINAFTER "CUSTOMER") UNDER THIS END USER LICENSE AGREEMENT (THE "AGREEMENT"). THIS AGREEMENT GOVERNS CUSTOMER'S INSTALLATION AND USE OF THE VERSION OF THE LICENSED SOFTWARE IDENTIFIED IN THE APPLICABLE PRODUCT ORDER, OR IF NOT ACQUIRED VIA A PRODUCT ORDER, CUSTOMER'S DOWNLOAD AND INSTALLATION OR USE OF THE LICENSED SOFTWARE CONSTITUTES ACCEPTANCE OF THIS AGREEMENT. **PLEASE READ THIS**

**AGREEMENT CAREFULLY, AS IT CONTAINS RESTRICTIONS ON CUSTOMER USE OF THE SOFTWARE. THIS AGREEMENT SUPERSEDES AND CONTROLS OVER ANY OTHER TERMS PROVIDED TO CUSTOMER REGARDING CUSTOMER'S USE OF THE LICENSED SOFTWARE, WHETHER WRITTEN OR ORAL, UNLESS A DIFFERENT WRITTEN AGREEMENT IS EXPRESSLY REFERENCED IN A PRODUCT ORDER OR EXECUTED BY LICENSOR AND CUSTOMER THAT SUPPLEMENTS OR SUPERSEDES ALL OR PORTIONS OF THIS AGREEMENT. ENTERING INTO THIS AGREEMENT DOES NOT CONSTITUTE A SALES TRANSACTION.**

**1. DEFINITIONS.** Capitalized terms in this Agreement are defined as follows:

**"Additional License Authorization" or "ALA"** means the additional specific software license terms that govern the use of a given software product, including (but not limited to) the provisions of the Non-Production Licensing Guide. The ALA(s) for Licensed Software are found at <https://software.microfocus.com/en-us/about/software-licensing> by product name, or can be provided by Micro Focus at Customer's request.

**"Customer" or "Licensee"** means the legal entity or individual that is identified in the applicable Product Order or who has rightfully received a license to the Licensed Product.

**"Documentation"** means the user documentation Micro Focus makes available for Licensed Software.

**"Licensed Product"** means Licensed Software and Documentation.

**"Licensed Software"** means the executable version of the software listed in the Product Order or otherwise provided to or rightfully acquired by Customer. This Agreement will govern the use of any update to the Licensed Software that Customer receives pursuant to a separate support and maintenance agreement as described in Section 7 (Support and Maintenance) below, unless such update contains, comes with, or is otherwise specifically governed by a different end user license agreement.

**"Micro Focus" or "Licensor"** means the applicable Micro Focus entity and its affiliates having intellectual property rights in Licensed Product.

**"Open Source Software"** means software or other material embedded in or made available with a Licensed Product where such software or other material is made available under an "open source license" as this term is commonly understood by members of the open source community, including, but not limited to, those licenses meeting all the criteria prescribed in the Open Source Definition provided by the Open Source Initiative (<https://opensource.org/osd>).

**"Product Order"** means a purchase order or purchase order alternative agreed to by the parties for the sale of a license(s) of one or more specific items of Licensed Software to Customer.

**"Third Party Component"** means any third party run time or other elements embedded in Licensed Software other than Open Source Software.

**"Third Party Software"** means additional or accompanying third party software (other than Open Source Software or Third Party Components) that is specified in the Documentation or in a file accompanying Licensed Software.

**"Warranty Period"** means the 90-day period starting from the date Licensed Software is delivered to Customer.

**2. PRODUCT ORDERS.** The licensing of software products takes place under Product Orders which (unless stated otherwise in the Product Order) incorporate the terms of this Agreement. Any terms that conflict or are in addition to the terms of this Agreement or any applicable ALA ("Inconsistent Terms") in a purchase order or other document issued by Customer are rejected by Micro Focus and have no force and effect. If there is any Inconsistent Term(s) in a Product Order, such Inconsistent Term(s) shall not apply except where such Inconsistent Term(s) is contained in a Micro Focus quote or a Product Order that is signed by both parties.

**3. LICENSING.**

**a. License.** Except as specifically permitted in the applicable ALA, or as described in Section 3b (Evaluation Licenses), Micro Focus and its affiliates, respectively deliver and license to Customer the Licensed Products under a non-transferable, non-sublicensable, non-exclusive license to use

Licensed Software and its Documentation as set out in this Agreement and/or the applicable ALA and solely for Customer's internal business operations and not for further distribution or commercialization.

- b. Evaluation Licenses.** Except as specifically permitted in the applicable ALA, when Micro Focus and its affiliates, respectively deliver and license the Licensed Products solely for evaluation, Customer receives a non-transferable, non-sublicensable, non-exclusive license to use Licensed Products for internal evaluation and testing purposes only, and not for any development, production, distribution or commercial purpose ("**Evaluation License**"). The term of an Evaluation License will be 30 days starting from the date Licensed Product is delivered (i.e., made available for download or physically delivered) to Customer ("**Evaluation Term**"), unless Micro Focus authorizes a different period in writing. The Licensed Product is provided "as is" and there are no warranties or obligations for Micro Focus to provide support. The Evaluation License terminates at the end of the Evaluation Term, and Customer is required to return, or, if Micro Focus so directs, delete and destroy, all copies of such Licensed Product and provide Micro Focus with written confirmation of its compliance with this provision within 30 days of the end of the Evaluation Term. The Evaluation License for any pre-release or beta versions of Licensed Software("Pre-Release Software") shall be for a term of 90 days unless Micro Focus authorizes a different period in writing. Customer agrees to promptly report to Micro Focus all problems (including errors, failures, nonconforming results, and unexpected performances) and any comments regarding the Pre-Release Software and to timely respond to all questionnaires submitted by Micro Focus regarding the results of Customer's testing of the Pre-Release Software. Micro Focus may choose not to release a final version of the Pre-Release Software or, even if released, to alter prices, features, specifications, capabilities, functions, release dates, general availability, or other characteristics of the Pre-Release Software.

#### **4. USE RESTRICTIONS.**

- a.** Except as specifically permitted in the applicable ALA or Documentation, Customer will not, directly or indirectly:

    - a.** Use Licensed Software for time-sharing, outsourcing, hosting, service bureau or like use, or permit access by, or use for the benefit of, any third party;
    - b.** Modify or create derivative works of Licensed Software;
    - c.** Reverse engineer, decrypt, disassemble or otherwise attempt to discover the source code of Licensed Software, except to the extent permitted by applicable law;
    - d.** Unbundle component parts of Licensed Software for separate use, where Licensed Software with multiple components is provided to Customer as a single product;
    - e.** Publish or disclose to third parties any evaluation or benchmarking of Licensed Software; or
    - f.** Alter, destroy, or remove any proprietary notices or labels on or embedded in Licensed Software.
  - b.** Customer may make a reasonable number of archival copies of Licensed Software and Documentation, and will reproduce all copyright and other proprietary rights notices appearing in or on Licensed Products, including notices of all third party suppliers, on all permitted copies.
- 5. TERM.** This Agreement and the license term for the Licensed Software granted herein is perpetual, unless a subscription/term license has been purchased by Customer (in which case the license term shall be set forth in the Product Order or ALA), and is subject to earlier termination as provided in Section 6 (Termination). If Customer has purchased a subscription/term license, such license shall automatically terminate upon expiry of such subscription/term, unless earlier terminated under Section 6.
- 6. TERMINATION.** Except as set forth herein, either party may terminate this Agreement, and/or any license granted, on written notice if the other party materially breaches the terms of this Agreement, or any applicable ALA or Product Order and does not cure the breach within 30 days of the date such party is notified of such breach. Micro Focus may terminate this Agreement, along with any or all licenses then in effect with Customer, immediately by giving Customer written notice of termination in the event that (i) Customer becomes insolvent, has a receiver appointed, or files for or has filed against it, liquidation, bankruptcy or analogous proceedings; or (ii) Customer infringes or misappropriates the intellectual property rights of Micro Focus. Termination shall be without prejudice to any other rights or remedies a party may have. In the event of any termination, Customer's license(s) to install, access or use the Licensed Software will immediately terminate, and Customer shall destroy and erase all copies of such Licensed Software in its possession or control and provide written certification to Micro Focus

that it has complied with this provision. Early termination of this Agreement or any Product Order will not entitle Customer to any credit or refund or reimbursement of any previously paid fees.

7. **SUPPORT AND MAINTENANCE.** Customer is not entitled to any updates to Licensed Software, unless Customer purchases (or may receive under a subscription/term license) maintenance and support services pursuant to Micro Focus' then current applicable standard maintenance and support agreement (which is found at <https://www.microfocus.com/support-and-services/maintenance-and-support-agreements/> or can be provided by Micro Focus at Customer's request).
8. **HARDWARE.** In the event that Micro Focus provides Licensed Software embedded in an appliance, or provides hardware to Customer for use in conjunction with Licensed Software, additional hardware terms and conditions will apply. In all other instances, Customer will obtain and install any necessary hardware for proper installation and implementation of Licensed Software.
9. **PROFESSIONAL SERVICES.** If Customer has Micro Focus or a Micro Focus affiliate perform any services with respect to Licensed Software (e.g., installation, implementation, maintenance, consulting or training), Micro Focus or its affiliate will provide those services at its then current standard terms and conditions and rates unless otherwise agreed in writing by the parties. Customer may agree to enter into a professional services engagement with Micro Focus or its affiliate through a separate agreement or statement of work.
10. **SOFTWARE-AS-A-SERVICE.** If Customer purchases access to an online software solution that Micro Focus makes available for use through a network connection ("SaaS"), then additional terms and conditions will apply governing Customer's access to and use of SaaS.
11. **LIMITED WARRANTY.** Micro Focus warrants for the Warranty Period that the Licensed Software substantially conforms in all material respects to the Documentation, and any media on which Micro Focus provides Licensed Software is free from defects in materials and workmanship under normal use.

Customer's sole and exclusive remedy for breach of such warranty is (i) repair or replacement of the applicable Licensed Software or media free of charge so that it substantially conforms to Documentation or (ii) if Micro Focus reasonably determines such remedy is not economically or technically feasible, a refund of the license fee and any maintenance fee paid for the Licensed Software for the current year. The license to use such Licensed Software will immediately terminate when Customer receives the refund.

The warranties in Section 11 (Limited Warranty) do not apply if the defects in Licensed Software or media result from: (i) failure to use Licensed Software in accordance with Documentation, this Agreement or the applicable ALA; (ii) malfunction of Customer's equipment or network; (iii) accident, neglect, or abuse; (iv) service by any unauthorized person; (v) other software used by Customer not provided by Micro Focus, or for which Licensed Software is not designed or licensed for such use; or (vi) any other cause occurring after initial delivery of Licensed Software or media to Customer, unless directly caused by Micro Focus. For purposes of this Agreement, Licensed Software is deemed delivered when it is first made available for download by, or physically delivered to, Customer.

Micro Focus has no responsibility for any claims made outside the Warranty Period.

The warranties in Section 11 (Limited Warranty) also apply to Third Party Components, but do not apply to (i) any free-of-charge Licensed Software or updates provided following the Warranty Period; or (ii) third party software that is not a Third Party Component.

12. **DISCLAIMER OF WARRANTY.** Except for the limited warranties in Section 11 (Limited Warranty), Licensed Products are provided "as is" without warranty of any kind. To the extent permitted by law, all implied or statutory terms, conditions, representations, and warranties (including without limitation all terms, conditions, representations and warranties regarding merchantability, quality or fitness for a particular purpose, title or non-infringement, or that may arise out of course of dealing, usage or trade practice) are expressly disclaimed and excluded to the extent allowed by applicable law. The limited warranties in this Agreement are provided on the basis that Customer is procuring Licensed Products for the purposes of a business and not for household or consumer use. Micro Focus does not warrant that operation of Licensed Software will be uninterrupted or error-free. Customer has sole responsibility to select Licensed Software that works with other software, applications or systems to achieve intended results.
13. **LIMITATION OF LIABILITY.**



- a. **Liability Cap.** In no event will any liability of one party to the other party arising out of or in connection with this Agreement exceed the greater of (i) \$250,000 or (ii) the total fees paid by Customer for the affected Licensed Software in the relevant Product Order(s) (including related maintenance and support). Nothing in Section 13a (Liability Cap) shall limit either party's liability for: willful misconduct or fraudulent misrepresentation; unauthorized use of intellectual property; breach of license; breach of confidentiality, excluding breach of duties for handling Personal Information (defined in Section 18 Privacy); death or bodily injury caused by negligence; non-payment of amounts owed; or any liability which may not be excluded or limited by applicable law.
  - b. **Mutual Disclaimer of Consequential Damages.** In no event will either party be liable for any indirect, special, incidental, consequential, punitive or similar damages; loss of profits, business, data or programs (including, but not limited to, the cost of recovery or replacement of such data or programs); loss, damage or any costs due to interruption, delay or inability to use Licensed Software, whether arising out of or in connection with this Agreement, even if informed of the possibility of such damages in advance.
  - c. **Scope.** The limitations and disclaimers in Section 13a (Liability Cap) and Section 13b (Mutual Disclaimer of Consequential Damages) apply to all causes of action, including but not limited to, breach of contract, breach of warranty, negligence, strict liability, misrepresentation and other torts.
  - d. **Exclusive Remedy.** The remedies in this Agreement are the parties' exclusive remedies and the limitations of Section 13a (Liability Cap) and 13b (Mutual Disclaimer of Consequential Damages) apply even if these remedies fail of their essential purpose. Customer may have other rights, including consumer rights, under the laws of the state or country where it is located.
  - e. **Free-of-Charge Software.** If Micro Focus provides Customer with any Licensed Software free-of-charge or under an Evaluation License, to the extent permitted by law, Micro Focus and its affiliates will not be responsible for any loss or damage to Customer, its customers, or any third parties caused by that Licensed Software which is free-of-charge.
- 14. OWNERSHIP.** Micro Focus International plc and its affiliates and their suppliers own all intellectual property rights in Licensed Products, and authorize Micro Focus to distribute Licensed Products under this Agreement. Customer's only rights in Licensed Products are the express licenses referenced in this Agreement or the applicable ALA.
- 15. OPEN SOURCE SOFTWARE AND THIRD PARTY SOFTWARE.** Open Source Software and Third Party Software are governed by the terms of their respective licenses and not the terms of this Agreement, notwithstanding anything to the contrary in any applicable ALA. Information about the Open Source Software may be found in a file accompanying the Licensed Software or in the Documentation or ALA.
- 16. LICENSE FEES AND PAYMENT TERMS.** Customer will pay the license fees set forth in the applicable Product Order for Licensed Software within 30 days of the date of invoice. Software license fees are non-refundable, except as provided in Section 11 (Limited Warranty) above, and will be paid without deduction or tax withholding. Software License fees are exclusive of any transportation charges, sales, use, value added, and other applicable taxes and duties, and all such amounts will be paid or reimbursed by Customer. Customer will be liable for all outstanding past due amounts, which will accrue interest (at the rate of 1.5% per month compounded or the maximum rate permitted by law if lower) and any collection costs for recovery of past due amounts.
- 17. LICENSE VERIFICATION.** Micro Focus has the right to verify Customer's compliance with licenses to the Licensed Software. (See Micro Focus License Compliance Charter at <http://supportline.microfocus.com/licensing/licVerification.aspx>, which Micro Focus can also provide at Customer's request.)

Customer agrees to keep records sufficient to show Customer's compliance, including serial numbers; license keys; logs; records identifying machines on which Licensed Software is installed, accessed, or from which Licensed Software can be accessed; the number of different users accessing or authorized to access Licensed Software (if applicable); and licensing metrics, reports, and copies of Licensed Software. Micro Focus may require Customer to provide information about its deployment of Licensed Software, which may be in the form of a questionnaire. Customer will have a reasonable time to complete the questionnaire (or other form of request) and provide it to Micro Focus with an authorized Customer signatory certifying the accuracy of the information furnished. Upon 10 days prior written

notice, Micro Focus or its designated representative may inspect Customer's records, systems and facilities, during Customer's normal business hours, to verify compliance with licenses to the Licensed Software. Customer agrees to cooperate with such verification. Information obtained will be used solely for compliance purposes and will otherwise be subject to the confidentiality provisions in Section 21 (Confidential Information) of this Agreement. If Customer has engaged in unlicensed installation, use of, or access to Licensed Software or infringed or misappropriated intellectual property rights in Licensed Software, or has otherwise breached this Agreement or an ALA (a "Non-Compliance"), without prejudice to Micro Focus' other rights or remedies, including, without limitation, injunctive relief, within thirty(30) days' notice of such Non-Compliance, Customer agrees to purchase sufficient licenses and or subscriptions and associated support and maintenance (12 months forward and any applicable back support and maintenance) to cure the Non-Compliance, by paying Micro Focus' current (as of the date of such additional purchase) list license fees and support and maintenance fees to Micro Focus, plus interest (compounded at 1.5% monthly or the maximum rate permitted by applicable law if lower) for such additional licenses from the commencement of the Non-Compliance until payment of the aforementioned fees, with interest payable even if an invoice was not issued at the time the Non-Compliance occurred. If Customer's Non-Compliance results in an underpayment of license fees of 5% or greater, Customer shall also reimburse Micro Focus for the reasonable cost of such audit in addition to other amounts due.

- 18.PRIVACY.** Customer is solely responsible for, and assumes all liability with respect to, its own collection, processing, storage, and transfer of any user data, including personally identifiable information, personal health and financial information, and other forms of personal information (collectively, "**Personal Information**"). Customer is solely responsible for notifying its users of proper use of such data. Customer is solely responsible for assessing the Licensed Product or any related product or service for compliance with any industry requirements applicable to Customer. Each party must comply with its respective obligations under all applicable laws, regulations, and industry standards regarding data collection and data privacy that apply to use of Licensed Software. Personal information or customer data that Customer provides to Micro Focus for the purpose of receiving products or services will be handled in accordance with the Micro Focus Privacy & Cookies Notice (<https://www.microfocus.com/en-us/legal#web-cookies>) and the privacy and data security provisions in the applicable ALA.
- 19.USE OF CUSTOMER INFORMATION.** To the extent permitted by law, Customer expressly consents to the collection and use of information about Customer's purchase, installation and use of Licensed Software and the computer systems on which it is installed or accessed as necessary to fulfill the Product Order and provide the Licensed Product, for security and licensing purposes and to improve Micro Focus products and services.
- 20.CUSTOMER FEEDBACK.** Customer agrees that, should it provide Micro Focus with any feedback or suggestions regarding Licensed Products ("**Feedback**"), Micro Focus and its affiliates will be free to use all such Feedback, including (but not limited to) all intellectual property rights in and to such Feedback, in their discretion and for any purpose, without obligation of any kind to Customer.
- 21.CONFIDENTIAL INFORMATION.** Information exchanged under or in connection with this Agreement, including all information pertaining to Pre-Release Software, will be treated as confidential if identified as confidential at time of disclosure, or if the circumstances of disclosure reasonably indicate such information should be treated as confidential. Confidential information may only be used for the purpose of fulfilling obligations or exercising rights under or in connection with this Agreement, and shared with employees, affiliates, agents or contractors with a need to know such information to support that purpose, who are contractually bound to protect its confidentiality. Confidential information will be protected using a reasonable degree of care to prevent unauthorized use or disclosure for three years from date of receipt. These obligations do not cover information that (i) was known or becomes known to the receiving party without a duty of confidentiality; (ii) is independently developed by the receiving party; (iii) becomes publicly available without breach of this Agreement; (iv) is disclosed with the disclosing party's prior written consent; or (v) where disclosure is required by law, a court or government agency. Should the receiving party be required to reveal confidential information under subpoena, court order or other operation of law, the receiving party will provide reasonable prior notice to the disclosing party and request a protective order, if available.
- 22.INDEMNIFICATION FOR INTELLECTUAL PROPERTY RIGHTS INFRINGEMENT.** Micro Focus will defend and/or settle any claims against Customer that Licensed Products furnished under this



Agreement infringe the intellectual property rights of a third party ("IP Infringement Claim"), provided: (i) Customer promptly notifies Micro Focus in writing of the IP Infringement Claim; (ii) Micro Focus has sole control of the defense and all related settlement negotiations; and (iii) Customer reasonably cooperates with Micro Focus in the defense of the IP Infringement Claim.

Micro Focus will pay all damages, costs, and expenses finally awarded (or agreed to by settlement) for any such IP Infringement Claim. Micro Focus will pay all reasonable out-of-pocket costs incurred by Customer for cooperation in the defense of the IP Infringement Claim. If, however, Customer wants separate legal representation, Customer will be responsible for the costs and fees of its separate counsel.

Should any Licensed Products provided under this Agreement become or, in Micro Focus' opinion, likely become, the subject of an IP Infringement Claim, Micro Focus may replace or modify affected Licensed Product so as to make it non-infringing and materially equivalent, or procure for Customer the right to continue using it. If neither alternative is reasonably available, once Customer has returned or destroyed all copies of the affected Licensed Product, Micro Focus will refund to Customer the full amount paid for affected Licensed Product less straight line depreciation on a five-year basis from date of delivery.

Micro Focus is not responsible for unauthorized use of Licensed Products, and has no obligations under Section 22 (Indemnification for Intellectual Property Rights Infringement), to the extent infringement results from (i) compliance with Customer's designs or instructions, (ii) a modification not authorized in writing by an authorized Micro Focus signatory, (iii) use or combination with software, equipment, or data not provided by Micro Focus, (iv) non-licensed use; or (v) Third Party Software or Open Source Software.

### **23.MISCELLANEOUS.**

**a. Assignment.** Micro Focus may assign this Agreement and any Product Orders to a parent or an affiliate. Customer may not assign or transfer this Agreement (or any Product Orders) or any of its rights or duties hereunder, including (but not limited to) by operation of law, without Micro Focus' prior written consent, which will not be unreasonably withheld, and payment of any applicable assignment or transfer fee. Any transaction or series of related transactions resulting in a change in the ownership of more than 50% of the voting equity of Customer will be deemed an assignment for purposes of this

provision. Any attempted assignment of this Agreement (or a Product Order) not in accordance with Section 23a (Assignment) will be null and void.

**b. Governing Law and Jurisdiction.** This Agreement and, subject to Section 15 (Open Source Software and Third Party Software), licenses purchased under applicable Product Orders, as well as any claims or causes of action, whether in contract, tort or statute, based on, arising under or relating to this Agreement, will be governed and enforced as follows: If Customer's applicable place of business is located in North America, all matters arising out of or relating to this Agreement are governed by the laws of the state of Delaware, U.S.A. If Customer is located in the United Kingdom, Australia, Brazil, France, Germany, Italy, Japan, the Netherlands, New Zealand, Spain or Singapore, all matters arising out of or relating to this Agreement are governed by the laws of the country in which Licensee is located. In the rest of the world, the laws of England govern all matters arising out of or relating to this Agreement. The applicable law shall apply without regard to conflicts of law provisions, and without regard to the United Nations Convention on the International Sale of Goods. Any suit, action, or proceeding arising out of or relating to this Agreement shall be subject to the exclusive jurisdiction of the courts of the country determining the applicable law, except that the courts of the State of Delaware shall have exclusive jurisdiction in North America, and Micro Focus will be allowed to apply for injunctive relief in any jurisdiction. Each party agrees to be subject to the above-described jurisdiction and waives any right it may have to object to such venue, including objections based on personal jurisdiction or inconvenient forum. The prevailing party in any proceeding has the right to recover costs and reasonable attorneys' fees as awarded by the court or arbitrator.

**c. Export Control.** Micro Focus and Customer will comply with their respective responsibilities as exporters and importers under laws and regulations applicable to the export, import or other transfer of the software, services and technology provided by Micro Focus under this Agreement, including the export, import and sanctions laws of the United States and other applicable jurisdictions. If Customer exports, imports, or otherwise transfers any Licensed Products provided under or in

connection with this Agreement (or any technical data related thereto), Customer is responsible for obtaining any required authorizations. Customer will not use Licensed Products for any purpose prohibited by applicable export laws, including nuclear, chemical, missile or biological weapons-related end uses. With respect to any Pre-Release Software provided to Customer, Customer represents and warrants that (i) it is a non-governmental entity,(ii) the Pre-Release Software will only be used for internal testing and evaluation, and will not be rented, leased, sold, sublicensed, assigned, or otherwise transferred, and that it will not transfer or export any product, process, or service that is the direct product of the Pre-Release Software, and (iii) it will only use the Pre-Release Software in the United States or the countries listed in Title 15, U.S. CFR Supplement No. 3 to Part 740 - License Exception ENC Favorable Treatment Countries. Customer agrees to indemnify and hold Micro Focus harmless from and against any damages, claims, losses, fines, settlements, attorneys' fees, legal fees and court costs and other expenses related to any such activities or any claims in connection with any breach of this Section.

- d. Survival.** Rights and obligations of the parties in Sections 4 (Use Restrictions), 5 (Term), 6 (Termination), 12 (Disclaimer of Warranty), 13 (Limitation of Liability), 14 (Ownership), 15 (Open Source Software and Third Party Software), 16 (License Fees and Payment Terms), 17 (License Verification), 18 (Privacy), 19 (Use of Customer Information), 20 (Customer Feedback), 21 (Confidential Information), 22 (Indemnification for Intellectual Property Rights Infringement) and 23 (Miscellaneous) will survive termination or expiration of this Agreement. Neither party will be liable for delays or non-performance beyond its reasonable control except for payment obligations
- e. Notices.** All notices permitted or required under this Agreement will be in writing, signed by the party giving notice, and delivered personally, by courier, telecopy, first class mail, electronic mail, or similar transmission to the other party. Notices to Micro Focus shall be addressed to: FAO: The Chief Legal Officer, Micro Focus. The Lawn, 22-30 Old Bath Road, Newbury, RG14 1QN, or Email [legalnotices@microfocus.com](mailto:legalnotices@microfocus.com). Notices to Customer shall be sent to its address listed on the applicable Product Order, or at such other address as may be supplied in writing. The date of personal delivery or the date of mailing will be the date of notice.
- f. Resellers.** Micro Focus' obligations with respect to products or services supplied by Micro Focus and procured by Customer from an authorized Micro Focus reseller are limited to the terms and conditions in this Agreement and the Documentation included with the Micro Focus supplied products and services. With purchases from a reseller, the applicable pricing and payment terms are as set out in the separate agreement between Customer and the reseller, and any terms in this Agreement related to Micro Focus pricing and payments shall not apply. Micro Focus is not responsible for the acts or omissions of the reseller, or for any other products or services that it supplies to Customer.
- g. Entire Agreement.** This Agreement and the applicable Product Order(s) and ALA(s) represent the entire understanding of the parties with respect to the subject matter of this Agreement and supersede any previous communications or agreements that may exist regarding the same subject matter.
- h. Order of Precedence.** Subject to Section 2 (Product Orders), any conflicting terms and conditions will be resolved according to the following order of precedence: the applicable Product Order, the applicable ALA, and this Agreement.
- i. Amendment.** No modification of this Agreement will be binding on the parties unless in writing signed by authorized representatives of Micro Focus and Customer.
- j. Waiver.** No waiver of any right under or in connection with this Agreement will be effective unless in writing, signed by authorized representatives of both parties. No waiver of any past or present right arising from any breach or failure to perform will be deemed to be a waiver of any future right arising under or in connection with this Agreement.
- k. Severability.** If any provision in this Agreement or the applicable ALA(s) or Product Order(s) is held invalid or unenforceable, that provision will be construed, limited, modified or, if necessary, severed, to the extent necessary, to eliminate its invalidity or unenforceability, and the other provisions will remain unaffected.

Micro Focus EULA - January 2, 2023

## Configuring an ODBC Data Source Name

An ODBC data source name (DSN) is a set of credentials for connecting with a database instance. If you use PostgreSQL, you must configure a DSN for the database that holds your workspace repositories.

## Creating a Shared Folder for Workspaces

The folder in which you plan to create a workspace must be shared with team members. It is typically convenient to share the folder before you create the workspace, but you can do it afterward if necessary, then refresh the workspace path as described in *Getting Started* in the EA documentation set.

You must be an administrator to create a shared folder. Perform the follow steps to create a shared folder for a workspace:

1. On the EA server, create a folder for an EA workspace.
2. Select the folder and choose **Sharing and Security** from the right-click menu. This opens the **Properties** dialog for the folder. In the Sharing tab for the Properties dialog, select **Share this folder on the network** (or, on a machine in a Windows domain, **Share this folder**). Enter the share name in the **Share name** field and click **Apply**.



**Note:** Do not embed spaces in the share name. Doing so might cause other users to be unable to access the folder.

3. Click **Permissions**. The **Permissions for Folder** dialog opens. Specify the appropriate permissions for users sharing the folder and click **OK**.

## Upgrading Workspaces

When you modify your EA configuration, you must upgrade every workspace created with the previous configuration. Only the master user can upgrade a workspace:



**Important:** Micro Focus strongly recommends that you backup the database and the workspace folder along with the `.xwp` file before performing the upgrade on an important workspace.

1. Choose **Start > All Programs > Micro Focus > Enterprise Analyzer > Enterprise Analyzer Administration**. This opens the EA Administration window.
2. In the Administration window, click **Administer > Upgrade Workspace**. This opens the **Upgrade workspace** dialog box.
3. Choose the workspace you want to upgrade, then click **OK**. This opens a **Workspace Upgrade** dialog box.
4. To begin the upgrade process, click **Start**. In the **Workspace Upgrade** dialog box you will see the upgrade process progress. The components that are being upgraded are highlighted and the checkbox next to each component is checked when the upgrade is complete. You can **Pause** the upgrade and **Resume** it later.



**Note:** Upgrades that have stopped due to an error can be reset from the **File** menu.

5. Optionally, click **Workspace Upgrade FileExport DDL Script** to export the DDL script to perform the upgrade and give it to a DBA.

# Troubleshooting the Installation

Follow the instructions in this section to troubleshoot an EA installation.

## Troubleshooting Workspace Access

The folder in which you plan to create workspaces must be shared with team members. If users are unable to access workspaces, it may be because:

- You have not shared the folder for workspaces. Share the folder, then refresh the workspace path as described in *Getting Started* in the EA documentation set.
- You shared the folder for workspaces after creating a workspace. Refresh the workspace path as described in *Getting Started* in the EA documentation set.
- You embedded spaces in the value of the **Share name** field for the folder. Remove the spaces, then refresh the workspace path as described in *Getting Started* in the EA documentation set.